

Silicon Schottky Diodes

- For low-loss, fast-recovery, meter protection, bias isolation and clamping application
- Guard ring protected
- Low forward voltage
- Pb-free (RoHS compliant) package ¹⁾
- Qualified according AEC Q101

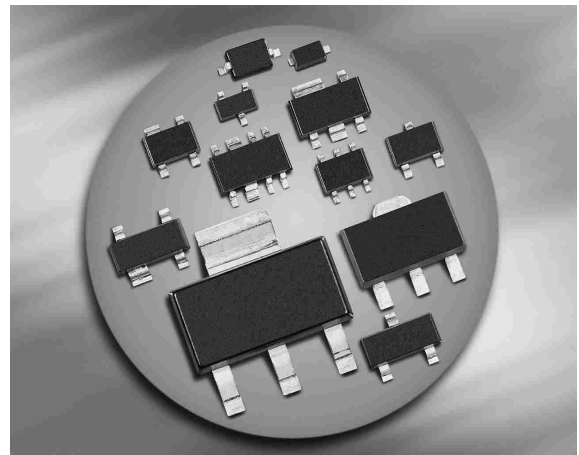

BAT54-02LRH
BAT54-02V
BAT54-03W

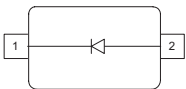

BAT54
BAT54W

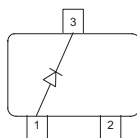

BAT54-04
BAT54-04W

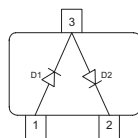

BAT54-05
BAT54-05W

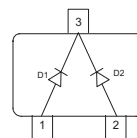

BAT54-06
BAT54-06W

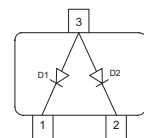

Type	Package	Configuration	L_S (nH)	Marking
BAT54	SOT23	single	1.8	T
BAT54-02LRH	TSLP-2-7	single	0.4	54
BAT54-02V	SC79	single	0.6	b
BAT54-03W*	SOD323	single	1.8	5/blue
BAT54-04	SOT23	series	1.8	TS
BAT54-04W	SOT323	series	1.4	TS
BAT54-05	SOT23	common cathode	1.8	TC
BAT54-05W	SOT323	common cathode	1.4	TC
BAT54-06	SOT23	common anode	1.8	TA
BAT54-06W	SOT323	common anode	1.4	TA
BAT54W	SOT323	single	1.4	T5

* Preliminary data

¹Pb-containing package may be available upon special request

Maximum Ratings at $T_A = 25^\circ\text{C}$, unless otherwise specified

Parameter	Symbol	Value	Unit
Diode reverse voltage	V_R	30	V
Forward current	I_F	200	mA
Non-repetitive peak surge forward current ($t \leq 10$ ms)	I_{FSM}	600	
Repetitive peak forward current ¹⁾ $t_p \leq 1$ s, $\delta = 0.5$	I_{FRM}	300	mA
Total power dissipation	P_{tot}		mW
BAT54, $T_S \leq 94^\circ\text{C}$		230	
BAT54-02LRH, $T_S \leq 135^\circ\text{C}$		230	
BAT54-02V, $T_S \leq 126^\circ\text{C}$		230	
BAT54-03W, $T_S \leq \text{tbd }^\circ\text{C}$		230	
BAT54-04, $T_S \leq 71^\circ\text{C}$		230	
BAT54-04W, $T_S \leq 117^\circ\text{C}$		230	
BAT54-05, $T_S \leq 48^\circ\text{C}$		230	
BAT54-05W, $T_S \leq 110^\circ\text{C}$		230	
BAT54-06, $T_S \leq 71^\circ\text{C}$		230	
BAT54-06W, $T_S \leq 117^\circ\text{C}$		230	
BAT54W, $T_S \leq 125^\circ\text{C}$		230	
Junction temperature	T_j	150	$^\circ\text{C}$
Storage temperature	T_{stg}	-65 ... 150	

¹⁾Device mounted on epoxy PCB 40 x 40 x 1.5 mm / 6 cm² Cu

Thermal Resistance

Parameter	Symbol	Value	Unit
Junction - soldering point ¹⁾	R_{thJS}		K/W
BAT54		≤ 245	
BAT54-02LRH		≤ 65	
BAT54-02V		≤ 105	
BAT54-03W		≤ tbd	
BAT54-04		≤ 345	
BAT54-04W		≤ 145	
BAT54-05		≤ 445	
BAT54-05W		≤ 175	
BAT54-06		≤ 345	
BAT54-06W		≤ 145	
BAT54W		≤ 110	

Electrical Characteristics at $T_A = 25^\circ\text{C}$, unless otherwise specified

Parameter	Symbol	Values			Unit
		min.	typ.	max.	
DC Characteristics					
Breakdown voltage ²⁾ $I_{(BR)} = 10 \mu\text{A}$	$V_{(BR)}$	30	-	-	V
Reverse current ²⁾ $V_R = 25 \text{ V}$	I_R	-	-	2	μA
Forward voltage ²⁾ $I_F = 0.1 \text{ mA}$	V_F	-	-	240	mV
$I_F = 1 \text{ mA}$		-	-	320	
$I_F = 10 \text{ mA}$		-	-	400	
$I_F = 30 \text{ mA}$		-	-	500	
$I_F = 100 \text{ mA}$		-	-	800	

¹⁾For calculation of R_{thJA} please refer to Application Note Thermal Resistance

²⁾Pulsed test: $t_p = 300 \mu\text{s}$; $D = 0.01$

Electrical Characteristics at $T_A = 25^\circ\text{C}$, unless otherwise specified

Parameter	Symbol	Values			Unit
		min.	typ.	max.	
AC Characteristics					
Diode capacitance $V_R = 1\text{ V}, f = 1\text{ MHz}$	C_T	-	-	10	pF
Reverse recovery time $I_F = 10\text{ mA}, I_R = 10\text{ mA}, \text{measured } I_R = 1\text{ mA}, R_L = 100\ \Omega$	t_{rr}	-	-	5	ns

Diode capacitance $C_T = f(V_R)$

$f = 1\text{MHz}$

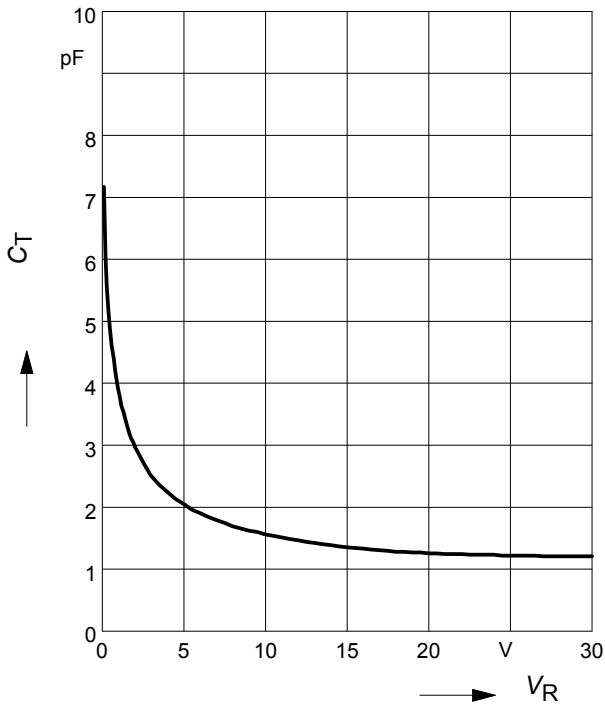

Reverse current $I_R = f(T_A)$

$V_R = \text{Parameter}$

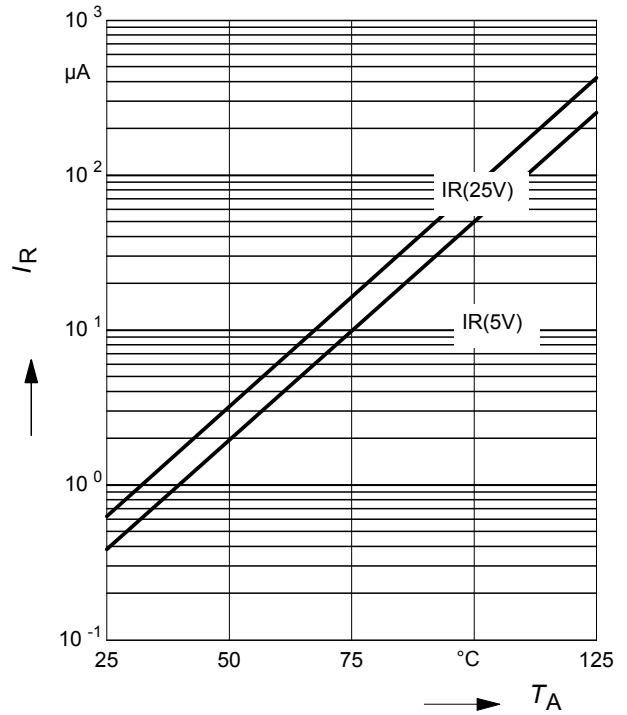

Reverse current $I_R = f(V_R)$

$T_A = \text{Parameter}$

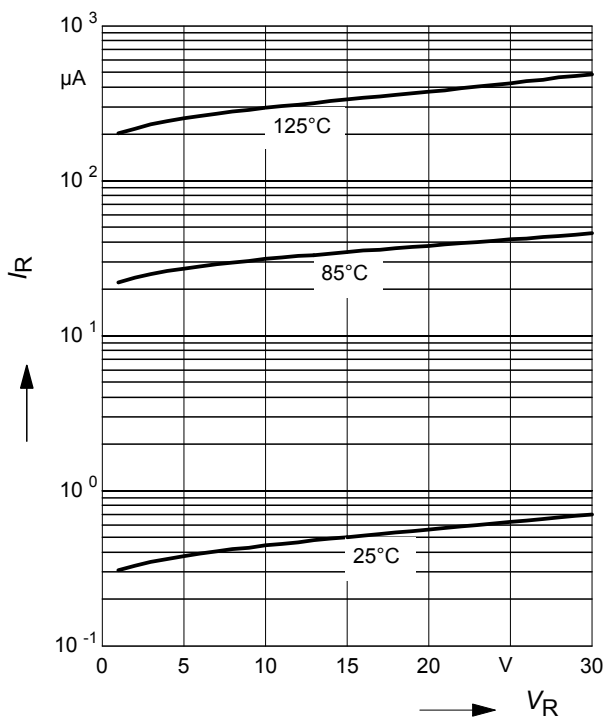

Forward Voltage $V_F = f(T_A)$

$I_F = \text{Parameter}$

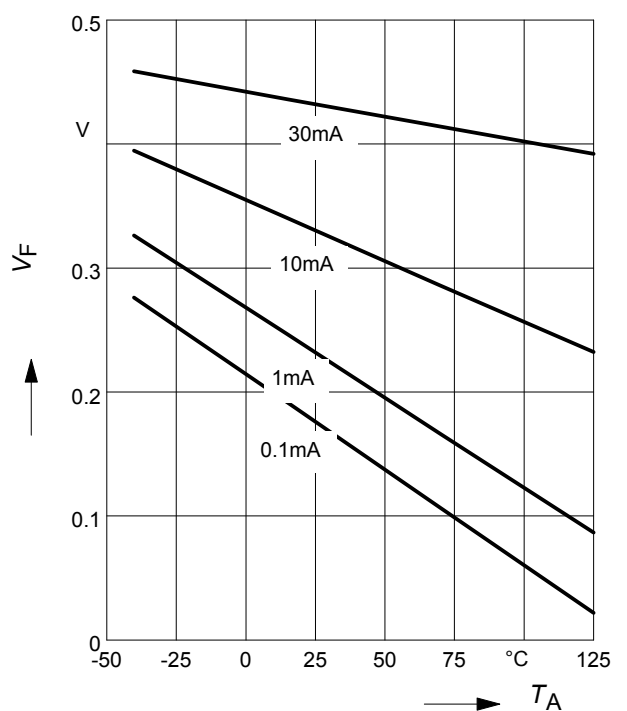

Forward current $I_F = f(V_F)$

$T_A =$ Parameter

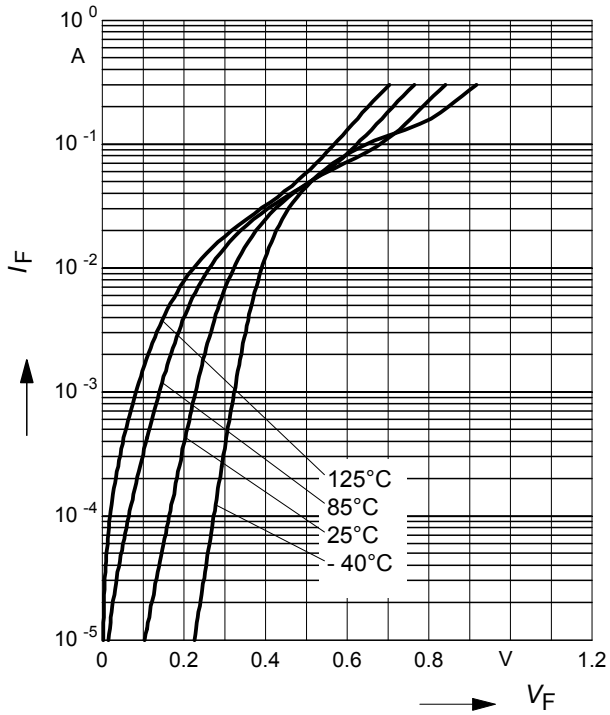

Forward current $I_F = f(T_S)$

BAT54

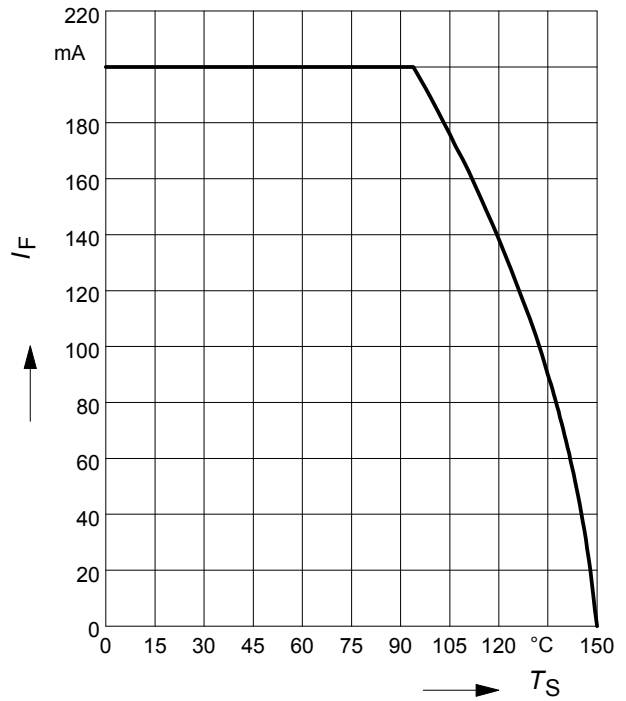

Forward current $I_F = f(T_S)$

BAT54-02LRH

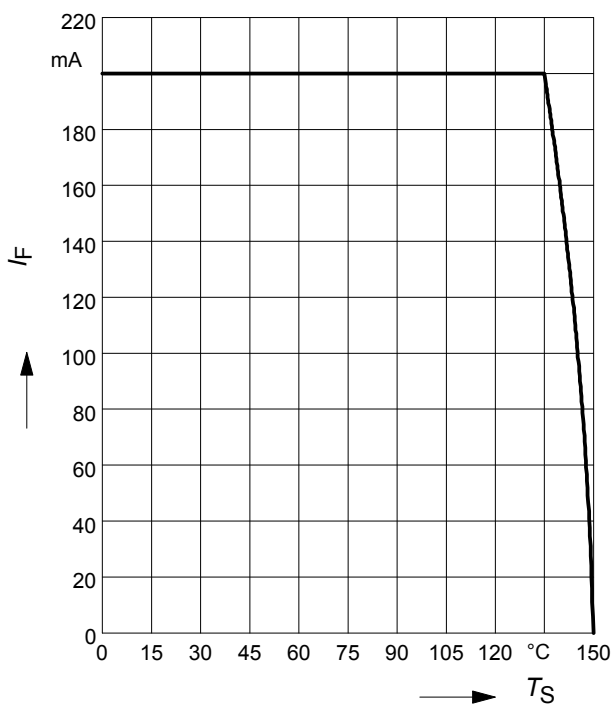

Forward current $I_F = f(T_S)$

BAT54-02V

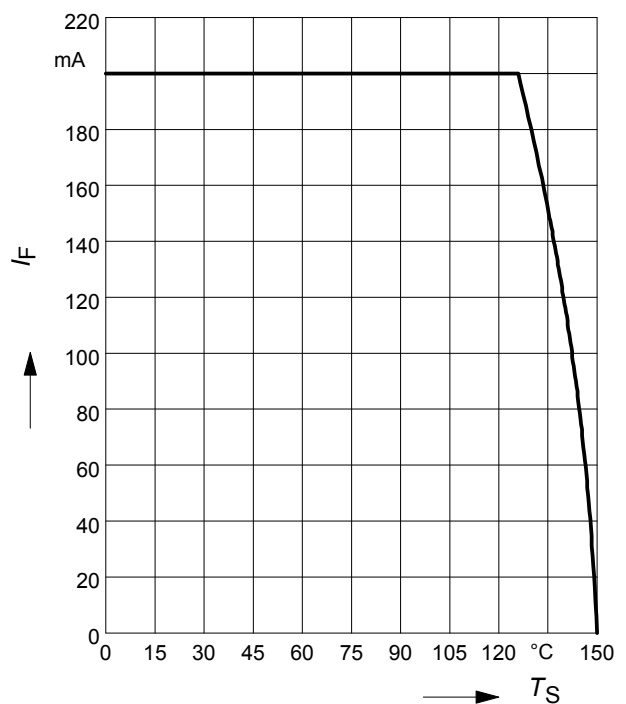

Forward current $I_F = f(T_S)$

BAT54-04

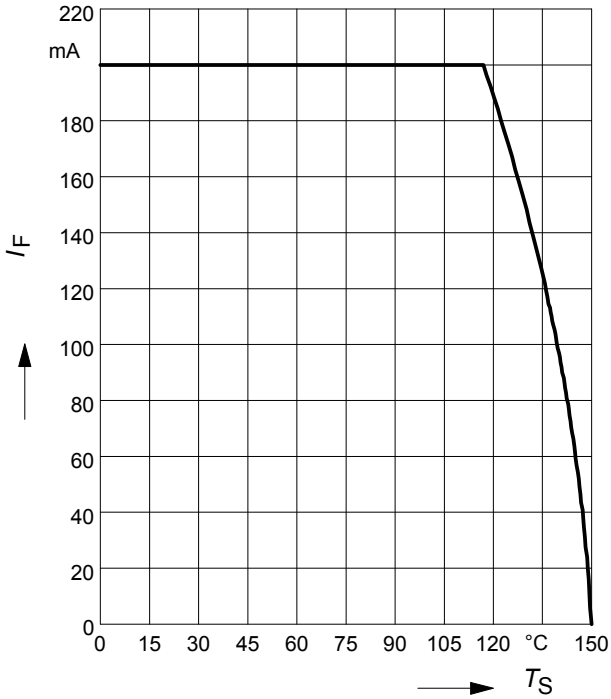

Forward current $I_F = f(T_S)$

BAT54-04W

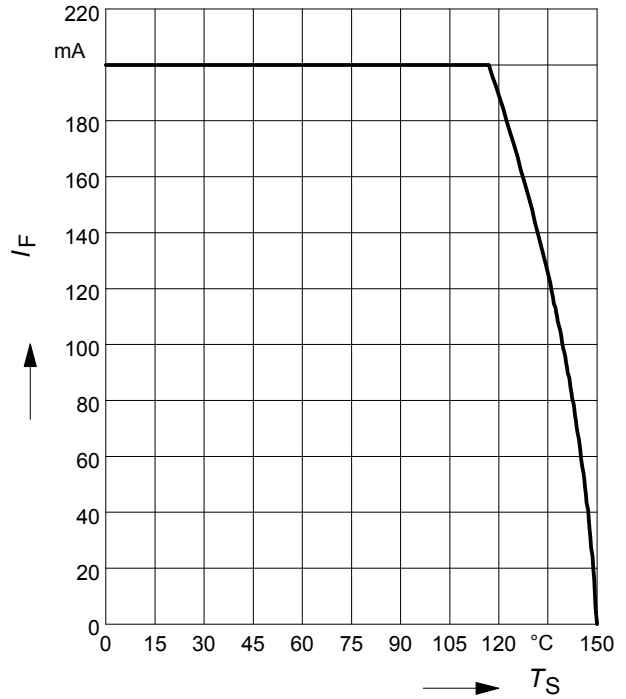

Forward current $I_F = f(T_S)$

BAT54-05

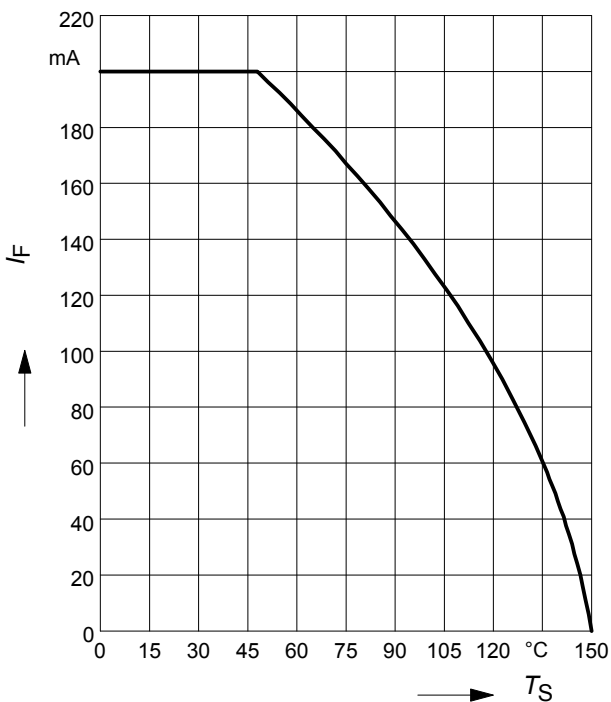

Forward current $I_F = f(T_S)$

BAT54-05W

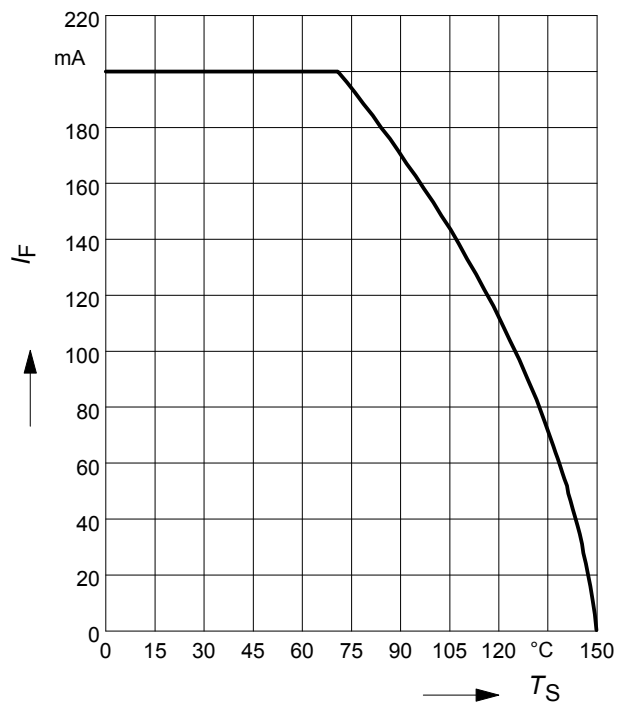

Forward current $I_F = f(T_S)$

BAT54-06

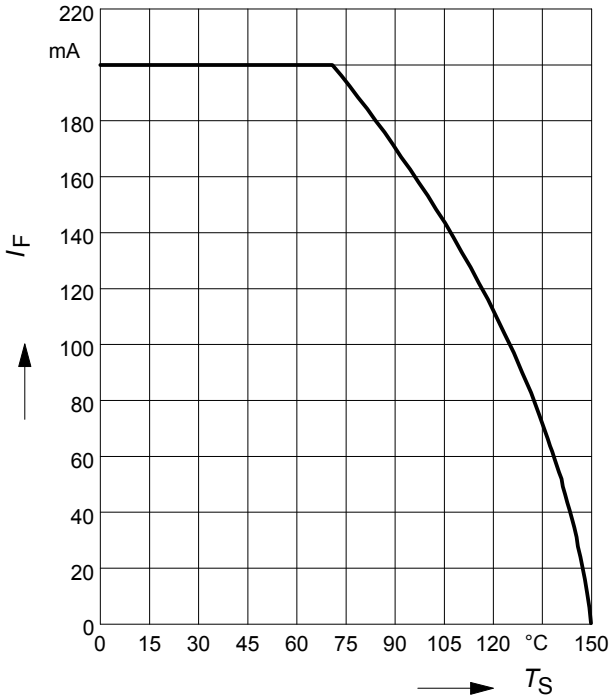

Forward current $I_F = f(T_S)$

BAT54-06W

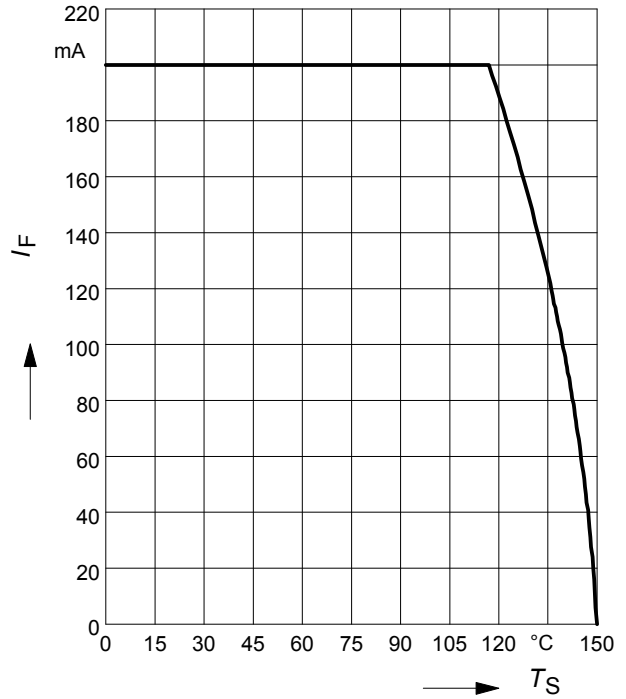

Forward current $I_F = f(T_S)$

BAT54W

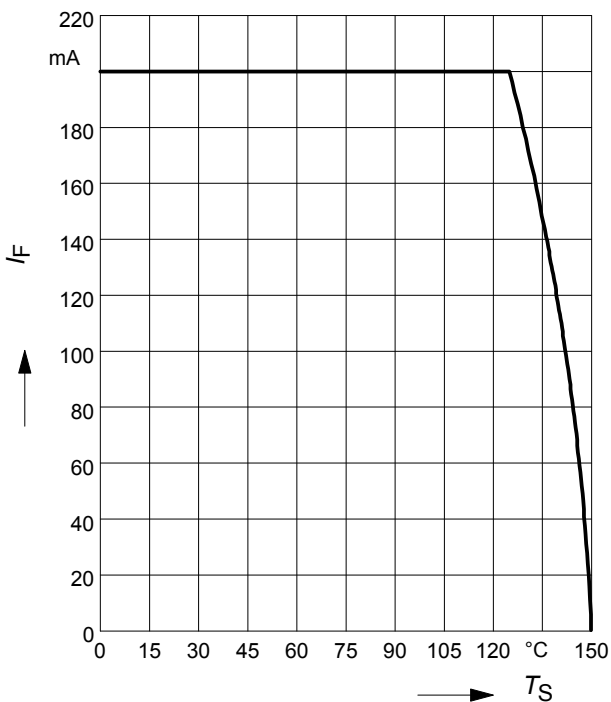

Package Outline

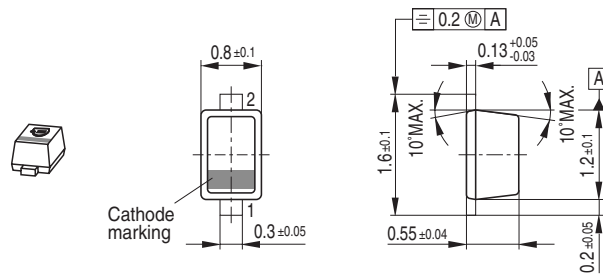

Foot Print

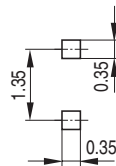

Marking Layout (Example)

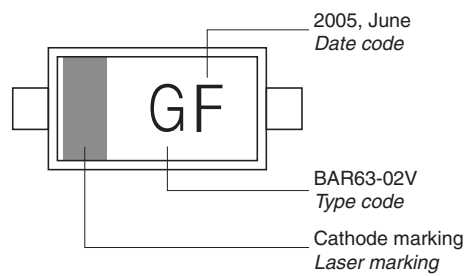

Standard Packing

Reel ø180 mm = 3.000 Pieces/Reel
 Reel ø180 mm = 8.000 Pieces/Reel (2 mm Pitch)
 Reel ø330 mm = 10.000 Pieces/Reel

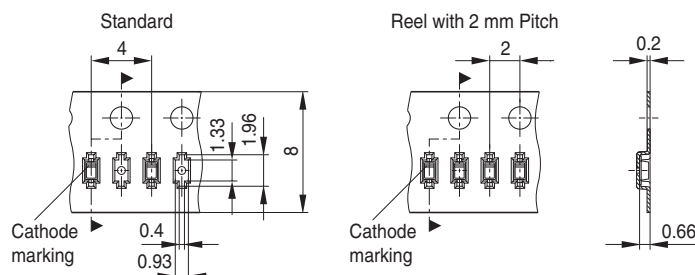

Date Code marking for discrete packages with one digit (SCD80, SC79, SC75¹⁾) CES-Code

Month	2003	2004	2005	2006	2007	2008	2009	2010	2011	2012	2013	2014
01	a	p	A	P	a	p	A	P	a	p	A	P
02	b	q	B	Q	b	q	B	Q	b	q	B	Q
03	c	r	C	R	c	r	C	R	c	r	C	R
04	d	s	D	S	d	s	D	S	d	s	D	S
05	e	t	E	T	e	t	E	T	e	t	E	T
06	f	u	F	U	f	u	F	U	f	u	F	U
07	g	v	G	V	g	v	G	V	g	v	G	V
08	h	x	H	X	h	x	H	X	h	x	H	X
09	j	y	J	Y	j	y	J	Y	j	y	J	Y
10	k	z	K	Z	k	z	K	Z	k	z	K	Z
11	l	2	L	4	l	2	L	4	l	2	L	4
12	n	3	N	5	n	3	N	5	n	3	N	5

1) New Marking Layout for SC75, implemented at October 2005.

Package Outline

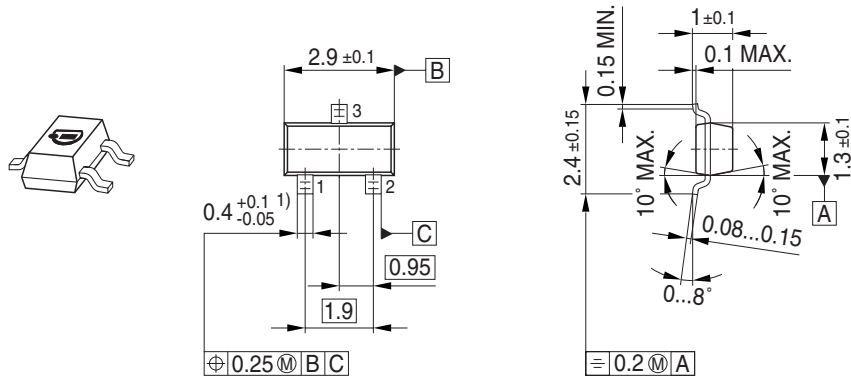

Foot Print

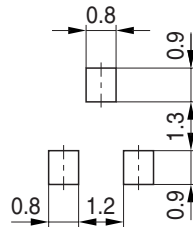

Marking Layout (Example)

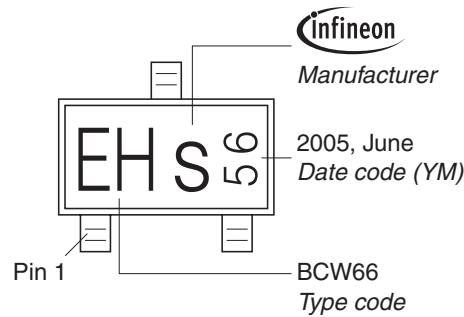

Standard Packing

Reel \varnothing 180 mm = 3.000 Pieces/Reel
 Reel \varnothing 330 mm = 10.000 Pieces/Reel

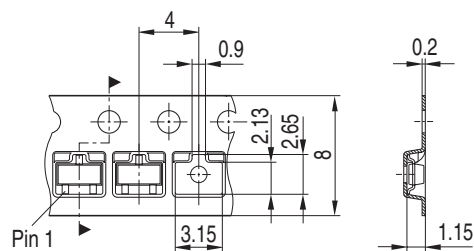

Package Outline

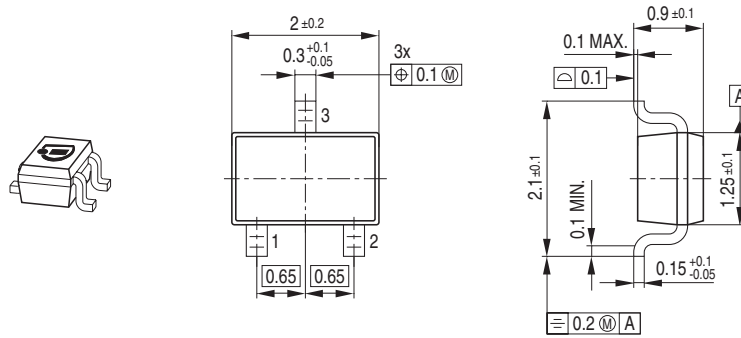

Foot Print

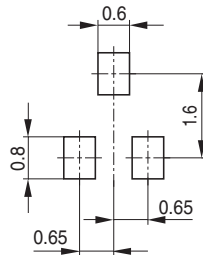

Marking Layout (Example)

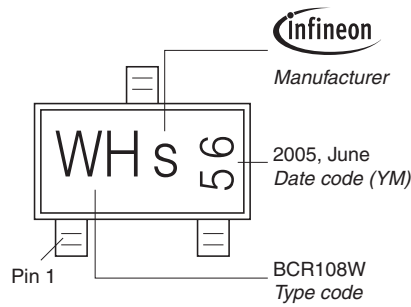

Standard Packing

Reel \varnothing 180 mm = 3.000 Pieces/Reel
 Reel \varnothing 330 mm = 10.000 Pieces/Reel

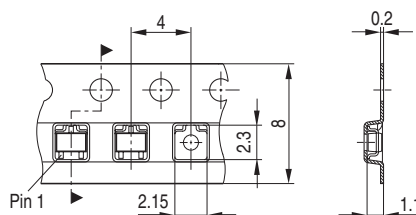

Package Outline

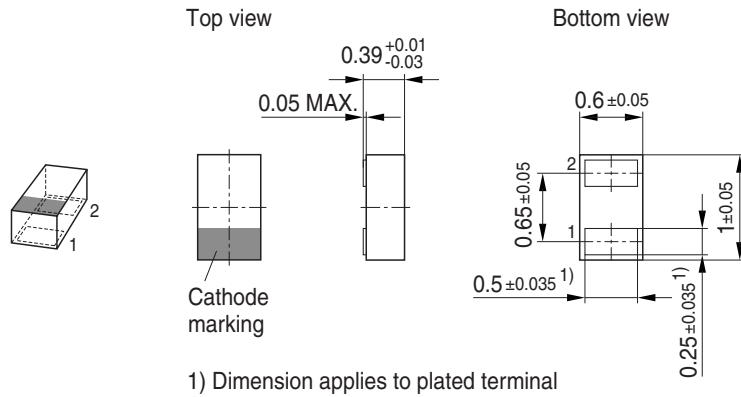

Foot Print

For board assembly information please refer to Infineon website "Packages"

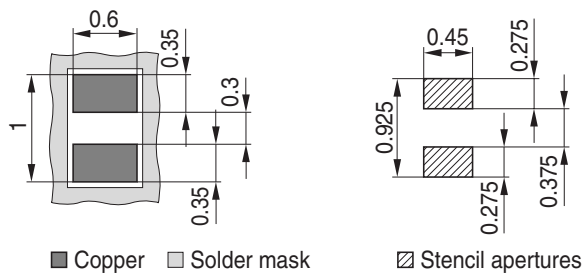

Marking Layout (Example)

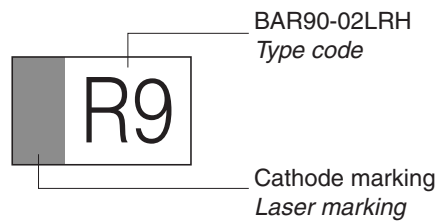

Standard Packing

Reel \varnothing 180 mm = 15.000 Pieces/Reel
 Reel \varnothing 330 mm = 50.000 Pieces/Reel (optional)

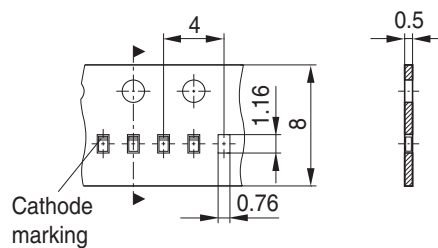

Edition 2006-02-01
Published by
Infineon Technologies AG
81726 München, Germany
© Infineon Technologies AG 2007.
All Rights Reserved.

Attention please!

The information given in this dokument shall in no event be regarded as a guarantee of conditions or characteristics ("Beschaffenheitsgarantie"). With respect to any examples or hints given herein, any typical values stated herein and/or any information regarding the application of the device, Infineon Technologies hereby disclaims any and all warranties and liabilities of any kind, including without limitation warranties of non-infringement of intellectual property rights of any third party.

Information

For further information on technology, delivery terms and conditions and prices please contact your nearest Infineon Technologies Office (www.infineon.com).

Warnings

Due to technical requirements components may contain dangerous substances. For information on the types in question please contact your nearest Infineon Technologies Office.

Infineon Technologies Components may only be used in life-support devices or systems with the express written approval of Infineon Technologies, if a failure of such components can reasonably be expected to cause the failure of that life-support device or system, or to affect the safety or effectiveness of that device or system.

Life support devices or systems are intended to be implanted in the human body, or to support and/or maintain and sustain and/or protect human life. If they fail, it is reasonable to assume that the health of the user or other persons may be endangered.